

4 in 1 100W DALI DT8 LED Driver (Constant Voltage)

70220094



Important: Read All Instructions Prior to Installation

Function introduction

I B L

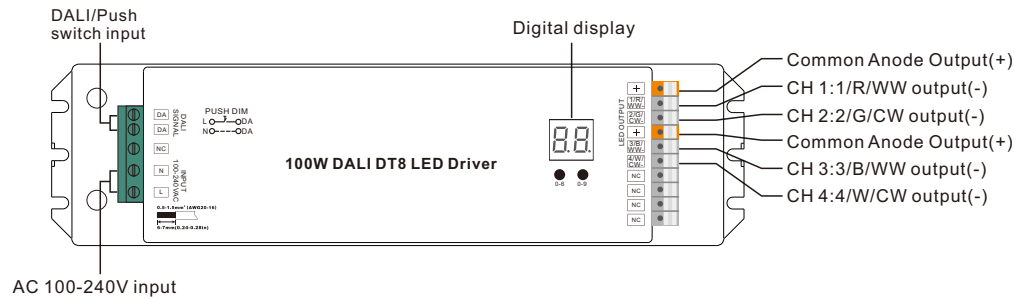

AC 100-240V input

Product Data

Output	LED Channel	4
	DC Voltage	24V DC
	Max. Current	Max. 4.1A/ch, ch1+ch2+ch3+ch4=4.1A
	Voltage Tolerance	±1%
	Rated Power	max. 100W
Input	Voltage Range	100-240V AC
	Frequency Range	50/60Hz
	Power Factor (Typ.)	> 0.90 @ 230VAC
	Total Harmonic Distortion	THD ≤ 15% (@ full load / 230VAC)
	Efficiency (Typ.)	90% @ 230VAC full load
	AC Current (Typ.)	1.2A @ 100VAC, 0.5A @ 230VAC
	Inrush Current (Typ.)	COLD START Max. 50A @ 230VAC
	Leakage Current	< 0.5mA /230VAC
Control	Dimming Interface	DALI DT8 (DALI consumption<2mA)/Push
	Dimming Range	0.1%-100%
	Dimming Method	Pulse Width Modulation
	Dimming Curve	Logarithmic
Protection	Over Current	Yes, recovers automatically after fault condition is removed
	Over Temperature	Yes, recovers automatically after fault condition is removed

Environment	Working Temp.	-20°C ~ +45°C
	Max. Case Temp.	75°C (Ta= "45°C")
	Working Humidity	10% ~ 95% RH non-condensing
	Storage Temp. & Humidity	-40°C ~ +80°C, 10% ~ 95% RH
Safety & EMC	Safety Standards	TUV EN61347-1, EN61347-2-13 approved
	Withstand Voltage	I/P-O/P: 3.75KVAC
	Isolation Resistance	I/P-O/P: 100M Ohms / 500VDC / 25°C / 70% RH
	EMC Emission	EN55015, EN61000-3-2, EN61000-3-3
	EMC Immunity	EN61547, EN61000-4-2,3,4,5,6,8,11, , surge immunity Line-Line 1KV
Others	MTBF	192500H, MIL-HDBK-217F @ 230VAC at full load and 25°C ambient temperature
	Dimension	244*64*32mm (L*W*H)

- 6 in 1 DALI DT8 LED driver, max. output power 100W total
- In compliance with IEC 62386-101:2014, IEC 62386-102:2014, IEC 62386-207 Ed2, IEC 62386-209:2011
- Built-in DALI-2 interface, DALI DT8 device
- 4 channels DC 24V constant voltage output
- Class 1 power supply, full isolated plastic case
- Power factor > 0.95, efficiency > 90%
- 6 universal device types in 1: Tc, T.c, X.6, XY, r9, t6 can be set by the buttons

- DALI DT8 device to control RGBW outputs or tunable white outputs via a single DALI address
- Color control as defined in the DALI specification device type 8
- Supports DT8 device commands, compatible with DALI masters that support DT8 commands
- Configuration via DALI master USB interface
- Numeric digital display for setting DALI address manually
- Compatible with universal AC push switch
- Compliant with Safety Extra Low Voltage standard
- Over load, over temperature protection
- IP20 rating, suitable for indoor LED lighting applications
- 5 years warranty

Safety & Warnings

- DO NOT install with power applied to device.
- DO NOT expose the device to moisture.

Installation

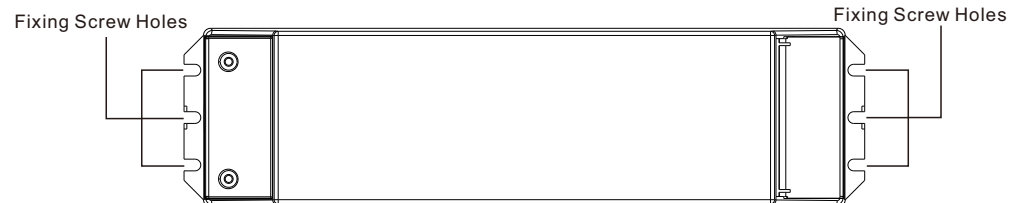

Note: when mounting the driver, please choose any one of the three fixing screw holes to fix with a screw at each end.

Operation

1. Select a DALI Device Type



- 1.1. Press and hold down both buttons until digital display flashes, then release the button.
- 1.2. Keep clicking the 2nd button, you will get the 8 device types one by one as follows, 6 of them are valid modes, please ignore the other 2 modes which are invalid here:

7C, means 2 Tc color type devices integrated in one control gear, which can control 2 groups of tunable white LED separately using 2 DALI addresses under this mode.

HC (invalid mode since this mode requires 5 PWM channels), means XY & Tc color type devices integrated in one control gear, which can control RGB & CCT LED separately using 2 DALI addresses under this mode.

rc (invalid mode since this mode requires 5 PWM channels), means RGBWAF & Tc color type devices integrated in one control gear, which can control RGB & CCT LED separately using 2 DALI addresses under this mode.

H6, means XY & DT6 type devices integrated in one control gear, which can control RGB & W LED separately using 2 DALI addresses under this mode.

H4, means XY coordinate color type, which can control RGB LED using 1 DALI address under this mode.

7C, means Tc color type, which can control tunable white LED using 1 DALI address under this mode.

rg, means RGBWAF color type, the device can control RGBW LED using 1 DALI address under this mode.

76, means DT6 device type, which can control single color LED using 1 DALI address under this mode.

- 1.3. Select a device type you would like and then press and hold down both buttons until digital display stops flashing to confirm the selection.



2. Setting DALI address

- 2.1. Press and hold down the first button on the left until digital display flashes, then release the button.
- 2.2. Click any of the two buttons once to select a digit, click again to change the digit until the desired DALI address appears. Click first button to set "tens" position and second button to set "units" position. The address can be set from 00-63.
- 2.3. Then press and hold down any of the 2 buttons until the numeric digital display stops flashing to confirm the setting.

Note: DALI address can be manually assigned from 00-63-FF, by factory defaults, no DALI address is

assigned for the dimmer, and the display shows **FF**. Setting DALI address as **FF** will reset the dimmer to factory defaults.

3. Once an address is selected, depending on the device type selected, the control gear may occupies 2 consecutive addresses or 1 address. For example, if the control gear is addressed to 22 on the display, when the device type is multi-addresses type, the control gear occupies address 22 & 23, when the device type is single-address type, the control gear occupies address 22.

4. DALI Address Assigned by DALI Masters

DALI address can also be assigned by DALI Master controller automatically, please refer to user manuals of compatible DALI Masters for specific operations.

Note: The digital display will show **AU** When the DALI master is assigning addresses. When the device type is multi-addresses type, the control gear will be discovered as 2 separate devices.

5. Push Dimmer Mode

While connected with an AC push switch, the digital display will show "PD" which means Push Dimmer Mode, operations under Push Dimmer Mode are as follows:

While **7C** device type is selected, only the 1st group tunable white LED will be controlled by the push switch,

- Click the button to switch ON/OFF
- Press and hold down the button to increase or decrease light intensity to desired level and release it, then repeat the operation to adjust light intensity to opposite direction. The dimming range is from 1% to 100%.
- Double click the button to switch between brightness mode and color temperature mode.
- Press and hold down the button to change color temperature under color temperature mode.

While **H6** device type is selected, only the RGB LED will be controlled by the push switch,

- Click the button to switch ON/OFF
- Press and hold down the button to increase or decrease light intensity to desired level and release it, then repeat the operation to adjust light intensity to opposite direction. The dimming range is from 1% to 100%.
- Double click the button to switch between brightness mode and RGB color mode.
- Press and hold down the button to change RGB colors under RGB color mode.

While **H4** or **rg** device type is selected, RGB LED will be controlled by the push switch,

- Click the button to switch ON/OFF
- Press and hold down the button to increase or decrease light intensity to desired level and release it, then repeat the operation to adjust light intensity to opposite direction. The dimming range is from 1% to 100%.
- Double click the button to switch between brightness mode and RGB color mode.
- Press and hold down the button to change RGB colors under RGB color mode.

While **7C** device type is selected, tunable white LED will be controlled by the push switch,

- Click the button to switch ON/OFF
- Press and hold down the button to increase or decrease light intensity to desired level and release it, then repeat the operation to adjust light intensity to opposite direction. The dimming range is from 1% to 100%.
- Double click the button to switch between brightness mode and color temperature mode.
- Press and hold down the button to change color temperature under color temperature mode.

While **76** device type is selected, single color LED will be controlled by the push switch,

- Click the button to switch ON/OFF
- Press and hold down the button to increase or decrease light intensity to desired level and release it, then repeat the operation to adjust light intensity to opposite direction. The dimming range is from 1% to 100%.

Memory function after power off or power failure enables the device to memorize the status before power off while power on again.

Product Dimension

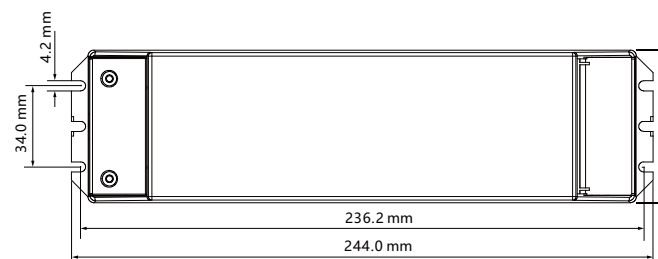

Wiring Diagram

1. With DALI Master

1.1 When **7C** multi-addresses Tc device type selected

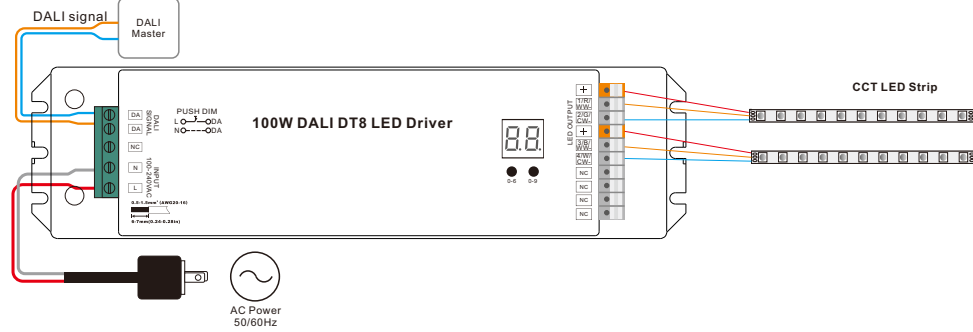

Note: 1) Please make sure that the DALI master controller supports Tc color type commands.
2) The control gear will be discovered by master controller as 2 separate Tc devices.

1.2 When **H6** multi-addresses XY+Single Color(DT6) device type selected

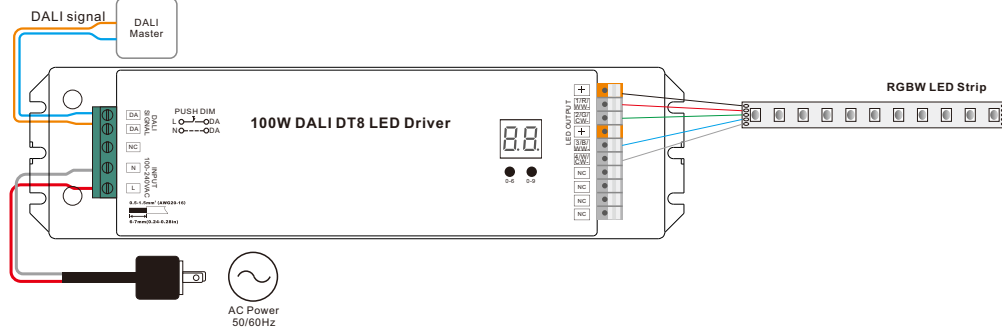

Note: 1) Please make sure that the DALI master controller supports XY & DT6 color type commands.
2) The control gear will be discovered by master controller as 2 separate devices: XY, DT6.

1.3 When **H4** single-address XY device type selected

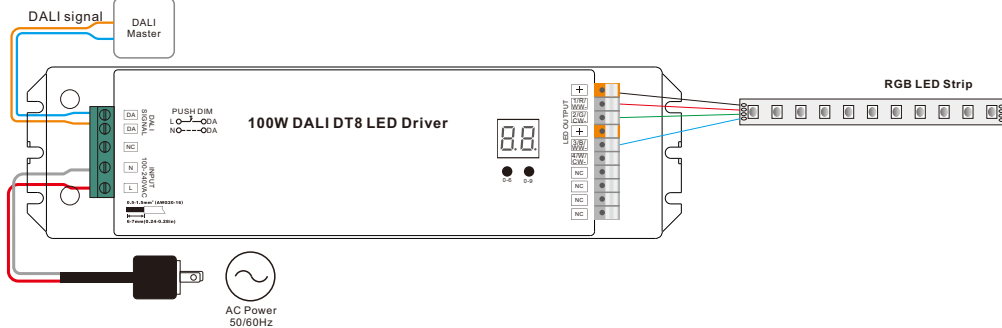

Note: Please make sure that the DALI master controller supports XY color type commands.

1.4 When **7C** single-address Tc device type selected

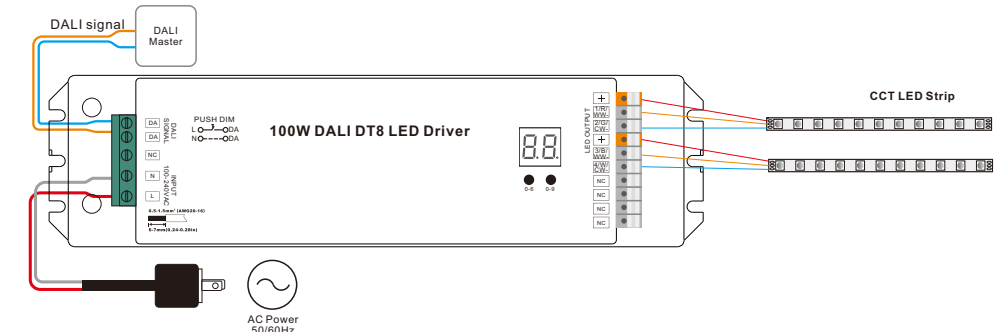

Note: 1) Please make sure that the DALI master controller supports Tc color type commands.
2) 2 groups CCT LED are controlled together.

1.5 When **r9** single-address RGBWAF device type selected

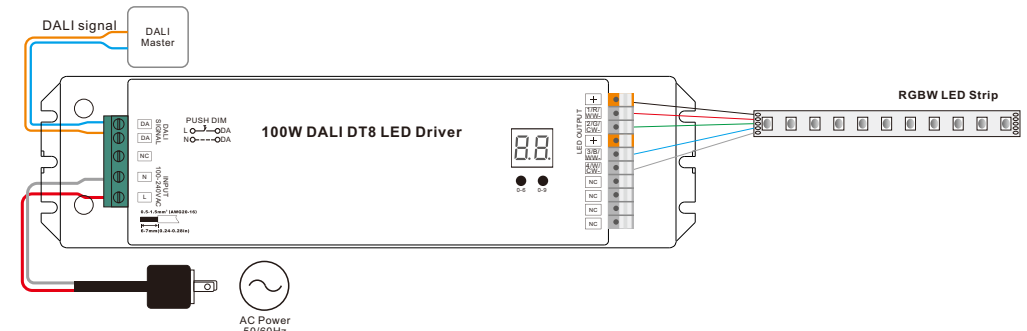

Note: Please make sure that the DALI master controller supports RGBWAF color type commands.

1.6 When **76** single-address DT6 device type selected

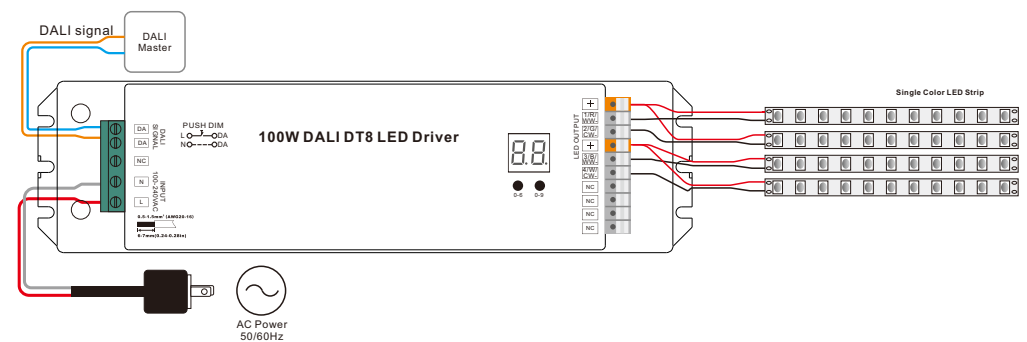

Note: The control gear will be discovered by DALI master as a DT6 device, 4 channels controlled together.

2. With AC Push

2.1 When **7c** multi-addresses Tc device type selected

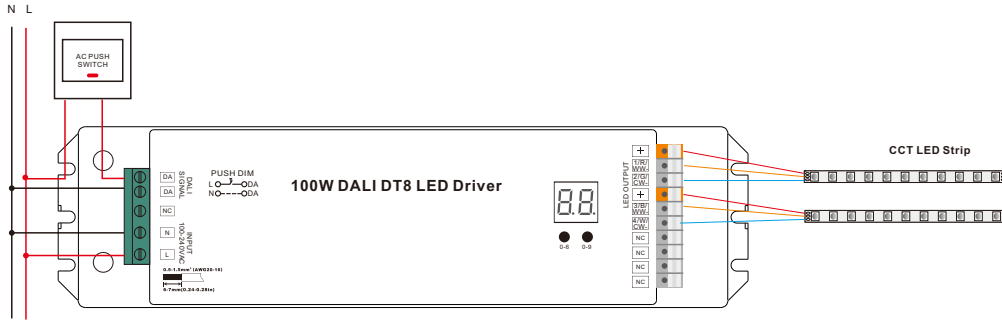

Note: only the 1st group CCT LED can be controlled under this mode.

2.2 When **H6** multi-addresses XY+Single Color(DT6) device type selected

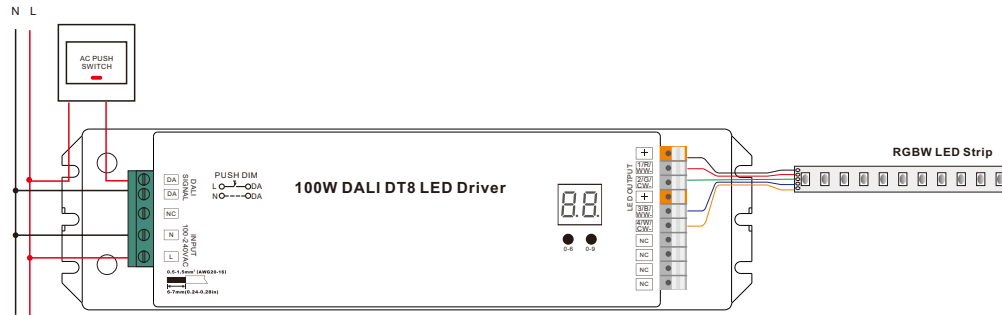

Note: 1) Please make sure that the DALI master controller supports XY & DT6 color type commands.
2) The control gear will be discovered by master controller as 2 separate devices: XY, DT6

2.3 When **H4** single-address XY device type selected

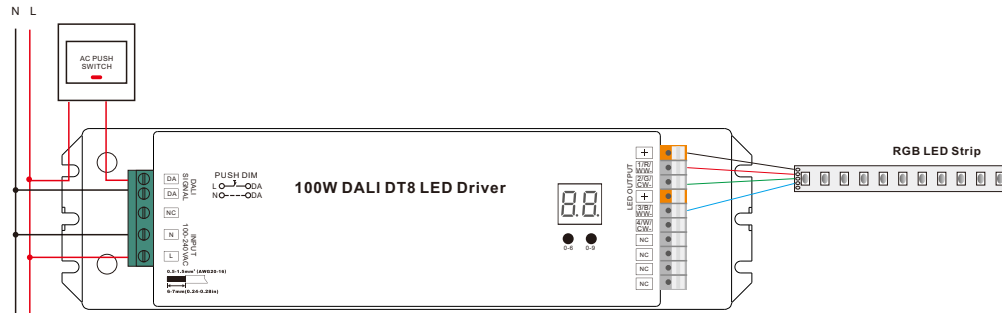

Note: Please make sure that the DALI master controller supports XY color type commands.

2.4 When **7c** single-address Tc device type selected

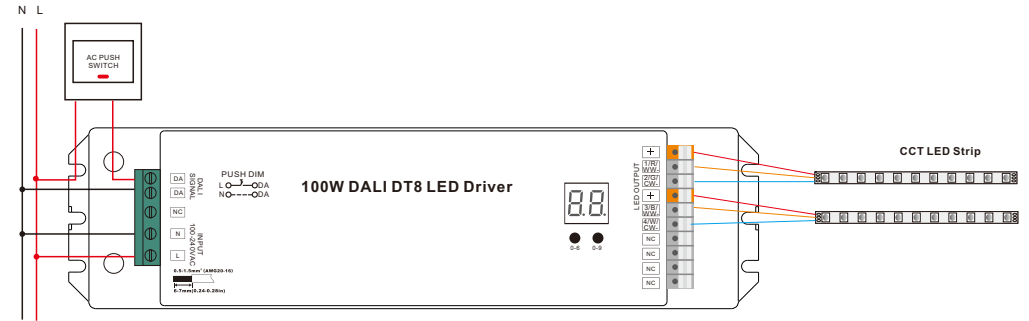

Note: 1) Please make sure that the DALI master controller supports Tc color type commands.
2) 2 groups CCT LED are controlled together.

2.5 When **r9** single-address RGBWAF device type selected

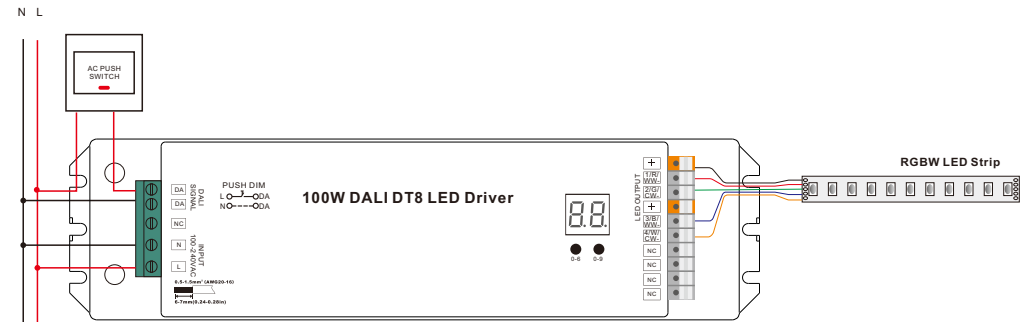

Note: Please make sure that the DALI master controller supports RGBWAF color type commands.

2.6 When **76** single-address DT6 device type selected

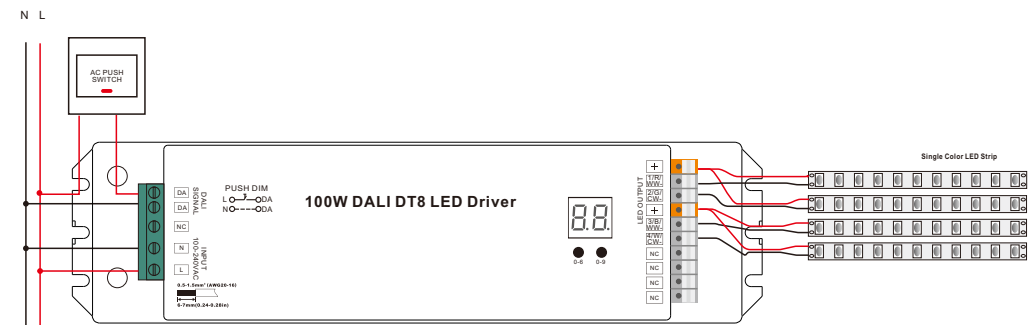

Note: all 4 channels are controlled together under this mode.